

FEATURES & BENEFITS

- Designed to meet the requirements of PAS 23 and PAS 24
- Licensed by Secured by Design
- 10 Year Guarantee
- Available as 35mm and 45mm Backsets, with 16mm and 20mm face bars
- Non-handed lock mechanism with reversible sash bolt to minimise stock requirements
- Snib facility as standard on all locks
- Central brass deadbolt throws 22mm to prevent unauthorised entry
- Accepts standard 92mm unsprung handles and euro profile cylinders (operates with all BS and DIN specification cylinders and most other types of cylinder)
- Split spindle for lever/pad applications - choice of length available
- Bi-directional throw of locking features - enhanced anti-jimmy feature
- Twin high security forged brass hooks for anti-separation resistance - 10mm (maximum) engagement into keeps
- Hooks deadlocked in the fully thrown position
- Patented adjustable steel keeps giving $\pm 2.0\text{mm}$ for composite and timber doors (non-adjustable composite and timber keeps also available)
- Optional shoot bolt engagement for additional security
- Single and French door (slave lock unit) application

LOCKING MECHANISM



KEEPS (COMPOSITE / TIMBER)



SHOOT BOLT (OPTIONAL)



10 YEAR GUARANTEE



FORCE RESISTANT



CORROSION RESISTANT



VARIETY OF EURO PROFILE CYLINDERS



ALTERNATIVE SPINDLE LENGTHS



The Door Lock People



POLICE PREFERRED SPECIFICATION

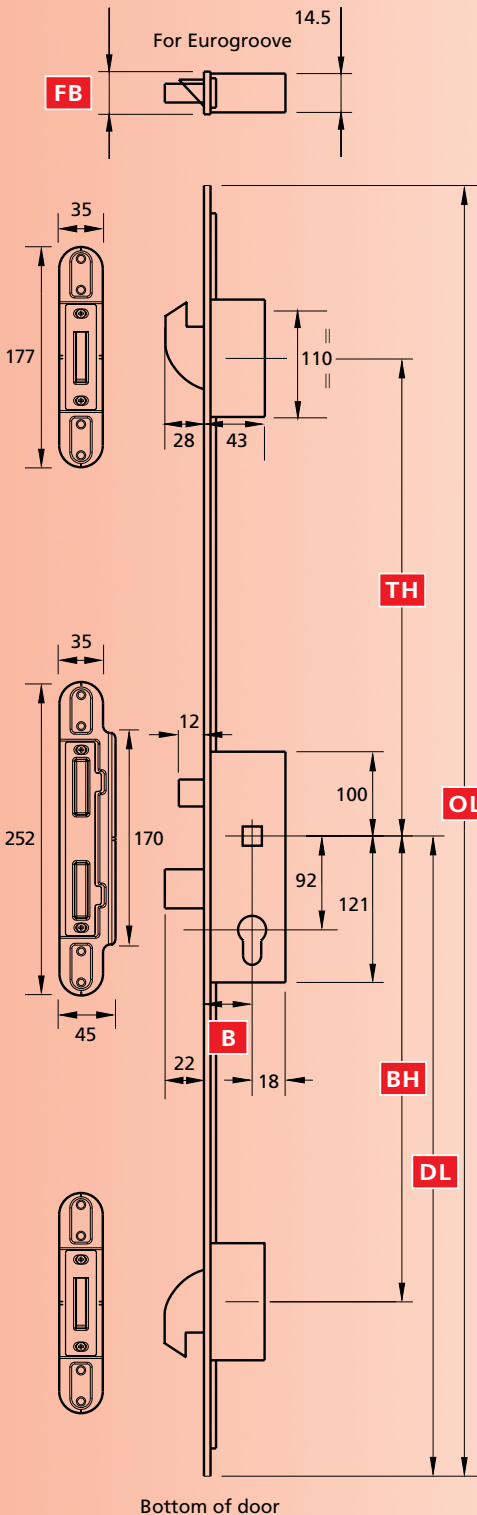

Bottom of door

Diagram illustrates product in locked position. Not to scale.

All dimensions are in mm and are nominal. ERA Products reserves the right to change specification without notice. Keeps illustrated are designed for composite and timber application.

Adjustable round end keeps illustrated.

ERA Products Ltd, Sales Tel: (01922) 490000 Free Fax Order Line: 0800 7832465
Website: www.era-security.com E-mail: info@era-security.com

To select the required 2 hook MPL part number, use the tables below to determine:

1. The face bar and backset
2. The overall length of the unit
3. The position of the hooks

KEY

B	Backset	TH	Top Hook
DL	Datum Line	BH	Bottom Hook
OL	Overall Length	FB	Face Bar

OPTION 1

B	FB	DL	OL	TH	BH	Part No.	Box Qty
35	16	1050	2250	570	662	6935-00-85AA	5
45	"	"	"	"	"	6945-00-85AA	"

OPTION 2

B	FB	DL	OL	TH	BH	Part No.	Box Qty
35	16	1050	2250	730	750	6935-00-85LA	5
45	"	"	"	"	"	6945-00-85LA	"
35	20	1050	2250	730	750	6935-80-85LA	"
45	"	"	"	"	"	6945-80-85LA	"

OPTION 3

B	FB	DL	OL	TH	BH	Part No.	Box Qty
35	16	1050	2100	680	700	6935-00-85MA	5
45	"	"	"	"	"	6945-00-85MA	"
35	20	1050	2100	680	700	6935-80-85MA	"
45	"	"	"	"	"	6945-80-85MA	"

OPTIONAL EXTRAS

B	SLAVE UNIT	SHOOT BOLTS	MAINTENANCE
35	•	•	All moving parts should be lightly lubricated using a light non-acidic mineral oil (e.g. "3 in 1") twice per year and the surface cleaned with a soft damp cloth. The product may need to be adjusted and fixings tightened to ensure a satisfactory operation.
45	•	•	

• Available - See pages 14 - 15 for more details

TECHNICAL INFORMATION

Corrosion resistance:	Plated to BS EN 1670 Grade 4
Operation:	Function test 100,000 cycles

MATERIALS

Lock case:	Steel BZP CR3 Passivate + Seal
Face bar:	Steel BZP CR3 Passivate + Seal
Hooks and dead/sash bolt:	Forged brass satin chrome plate
Keeps:	Steel BZP CR3 Passivate + Seal

