

DOOR ACCESSORIES

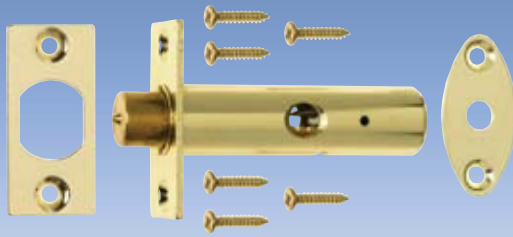

DOOR SECURITY BOLT



THUMBTURN



SPLINED KEY

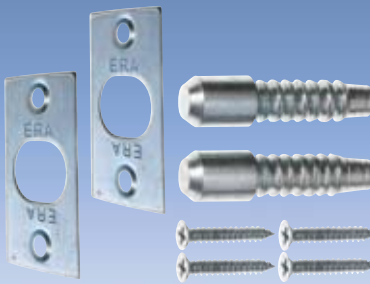

HINGE BOLTS

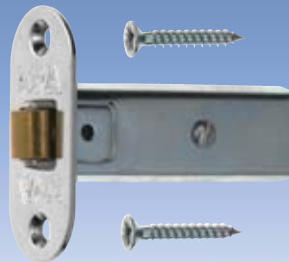

ROLLER LATCH

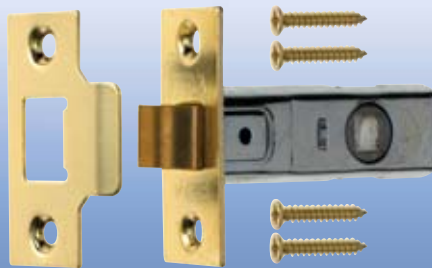

TUBULAR LATCH

The **ERA Door Security Bolt** offers concealed security for all internal and external doors. The separate splined key locks and unlocks from one side only.

The **ERA Thumbturn** is permanently fixed to the door in conjunction with a door security bolt. It is easily located in the event of an emergency and allows privacy when used on internal doors. It is also suitable as a security measure for cupboards and internal doors. It is available individually as a replacement for a key where a security bolt is already fitted.

The **ERA Hinge Bolt** offers added security on external doors with exposed hinges, helping to prevent doors being forced off their hinges. This bolt is suitable for all wooden internal and external doors. Manufactured from hardened steel it resists hacksawing. Hinge bolts are essential for all outward opening doors.

The **ERA Tubular Latch/Roller Latch** are suitable for all internal doors.

ORDERING DETAILS

Security Bolt and Splined Key

White	838-12
Brass	838-32
Satin	838-52
Saver Pack - 2 brass bolts plus 1 free key	838-33
Splined Key	506-52

Thumbturn

Brass	843-32
Satin	843-52
Polished Chrome	843-62

Hinge Bolts

Satin	740-52
-------	---------------

Roller Latch

Roller latch 64mm (2.1/2") Brass.bulk	187-36
---------------------------------------	---------------

Roller latch 64mm (2.1/2") Satin.bulk	187-56
---------------------------------------	---------------

Tubular Latch

Brass 64mm (2 1/2")	188-32
---------------------	---------------

Satin 64mm (2 1/2")	188-92
---------------------	---------------

Brass 76mm (3")	189-32
-----------------	---------------

Satin 76mm (3")	189-92
-----------------	---------------

Rounded forends and keeps available please contact ERA sales for more information

Door Security Bolt & Key

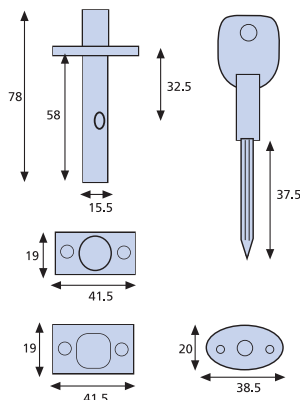

Thumb Turn

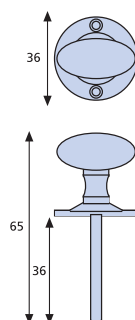

Hinge Bolt

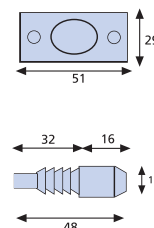

Tubular Latch

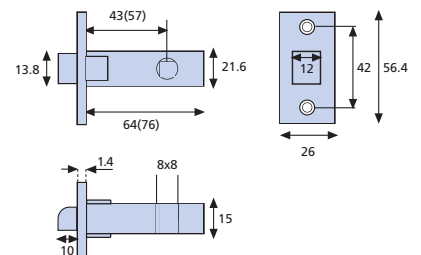

All dimensions in mm.

Numbers in brackets relate to 3" version of latch